

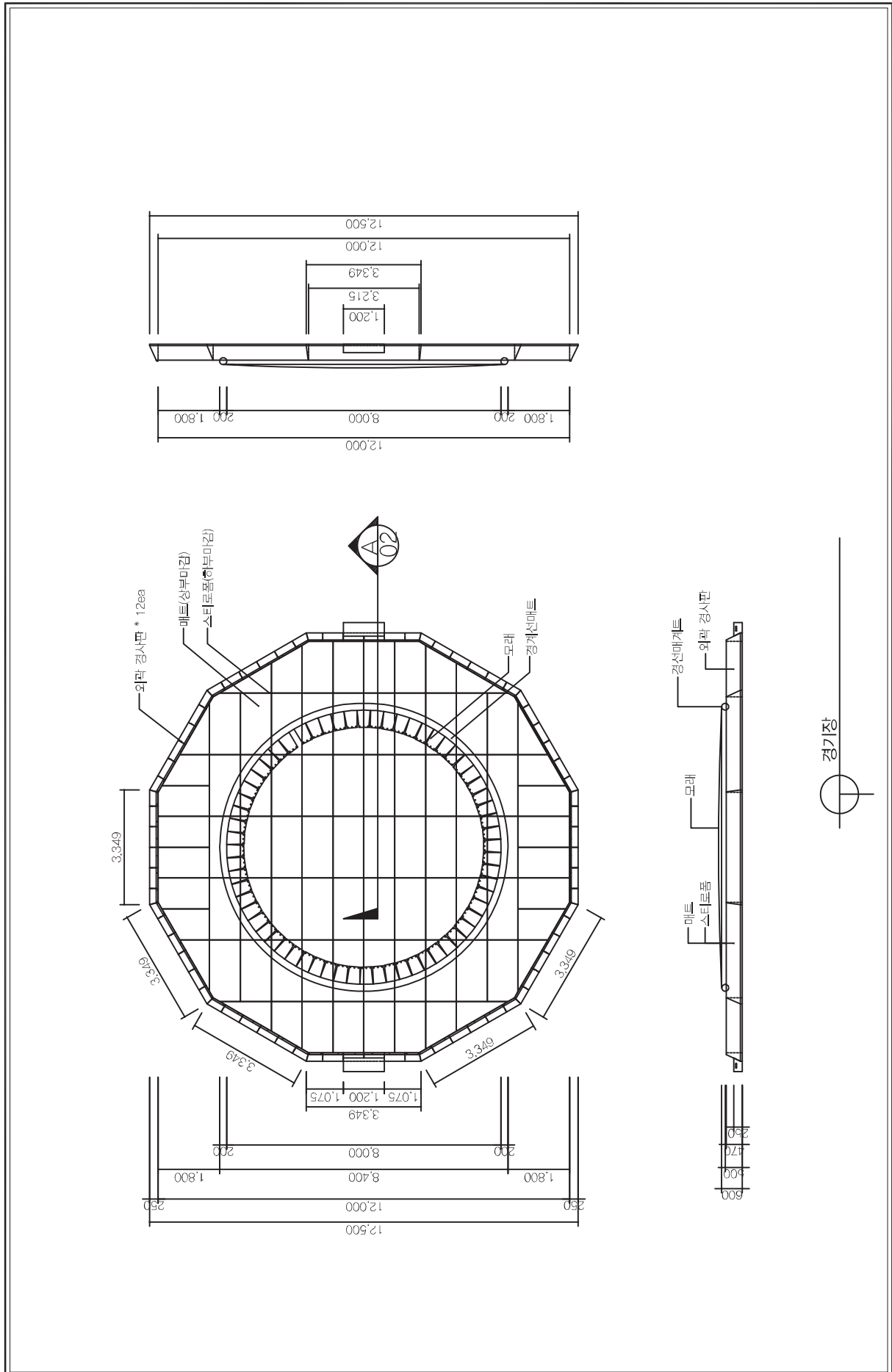

씨름디자인개선
씨름 경기장 제작 도면

2017. 03. 20.

대한씨름협회



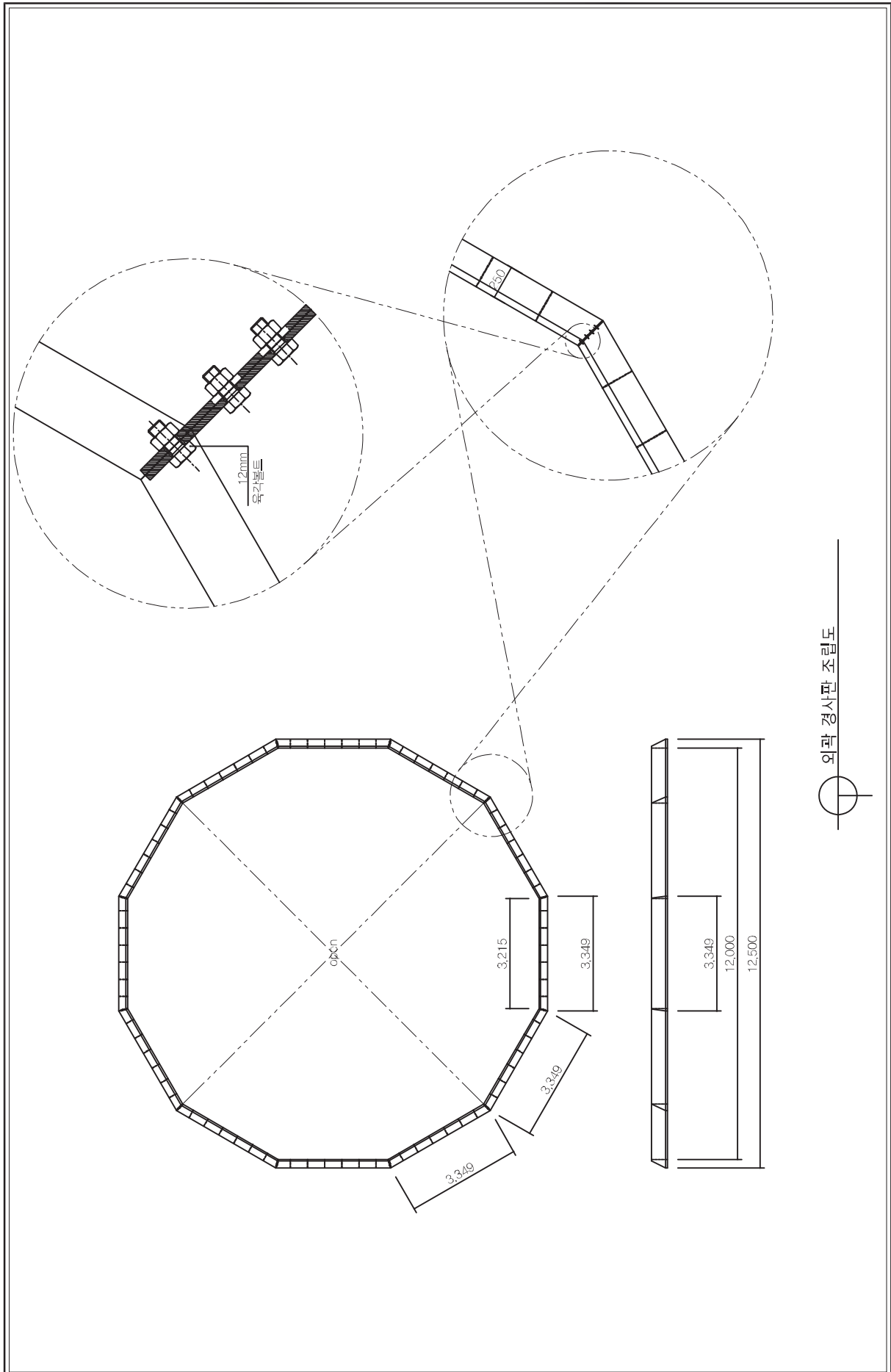

외관 경사판 조립도

Quantity : 12ea

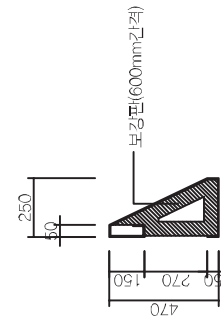
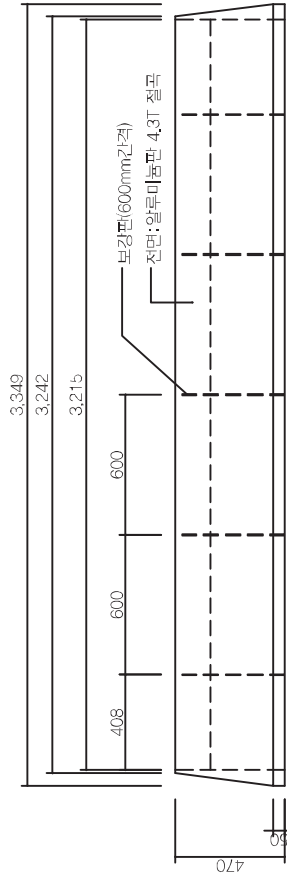
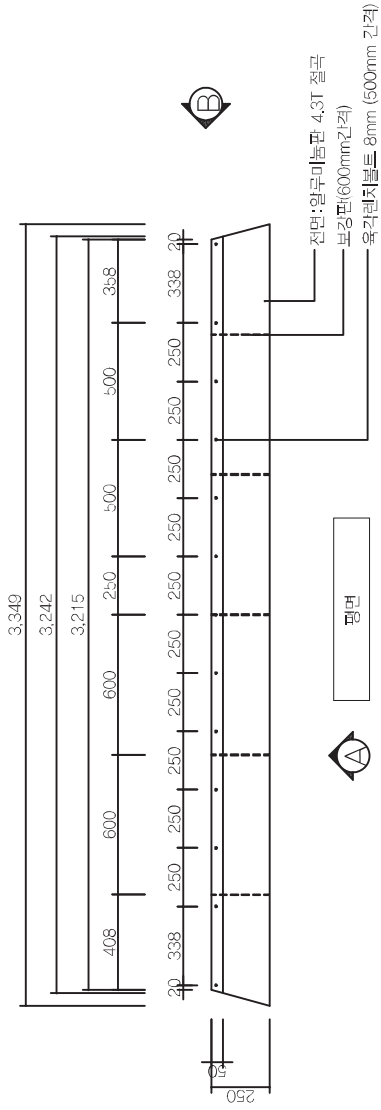

외각 경사판

Quantity : 12ea

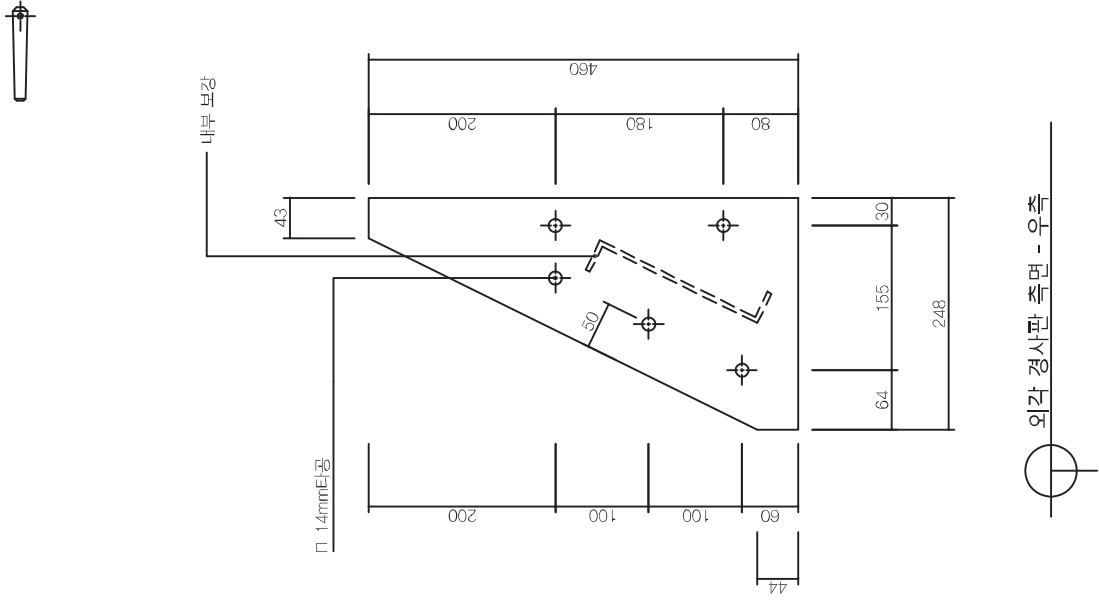

외각 경사판 측면 - 우측

Quantity : 12ea

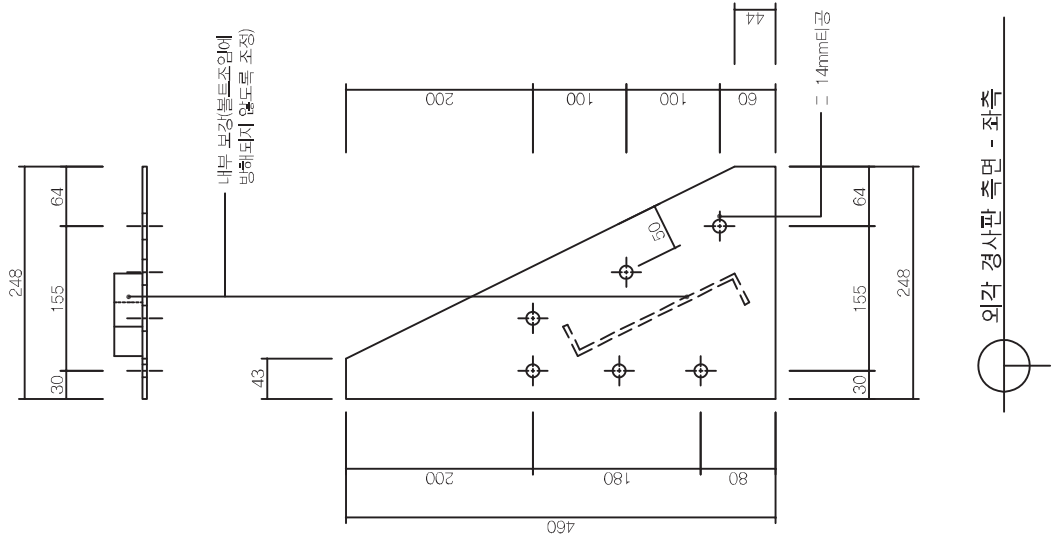

외각 경사판 측면 - 좌측

Quantity : 12set

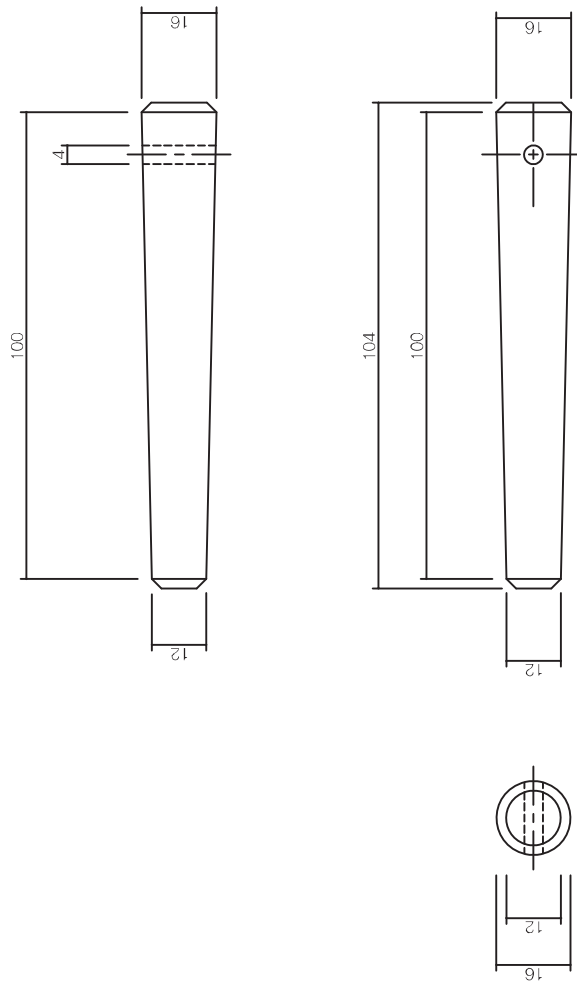

볼트구멍 위치고정 핀



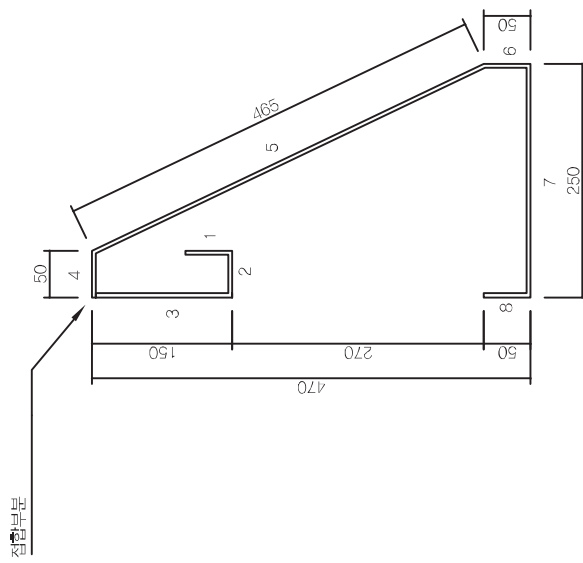

외각 경사판 절곡 단면

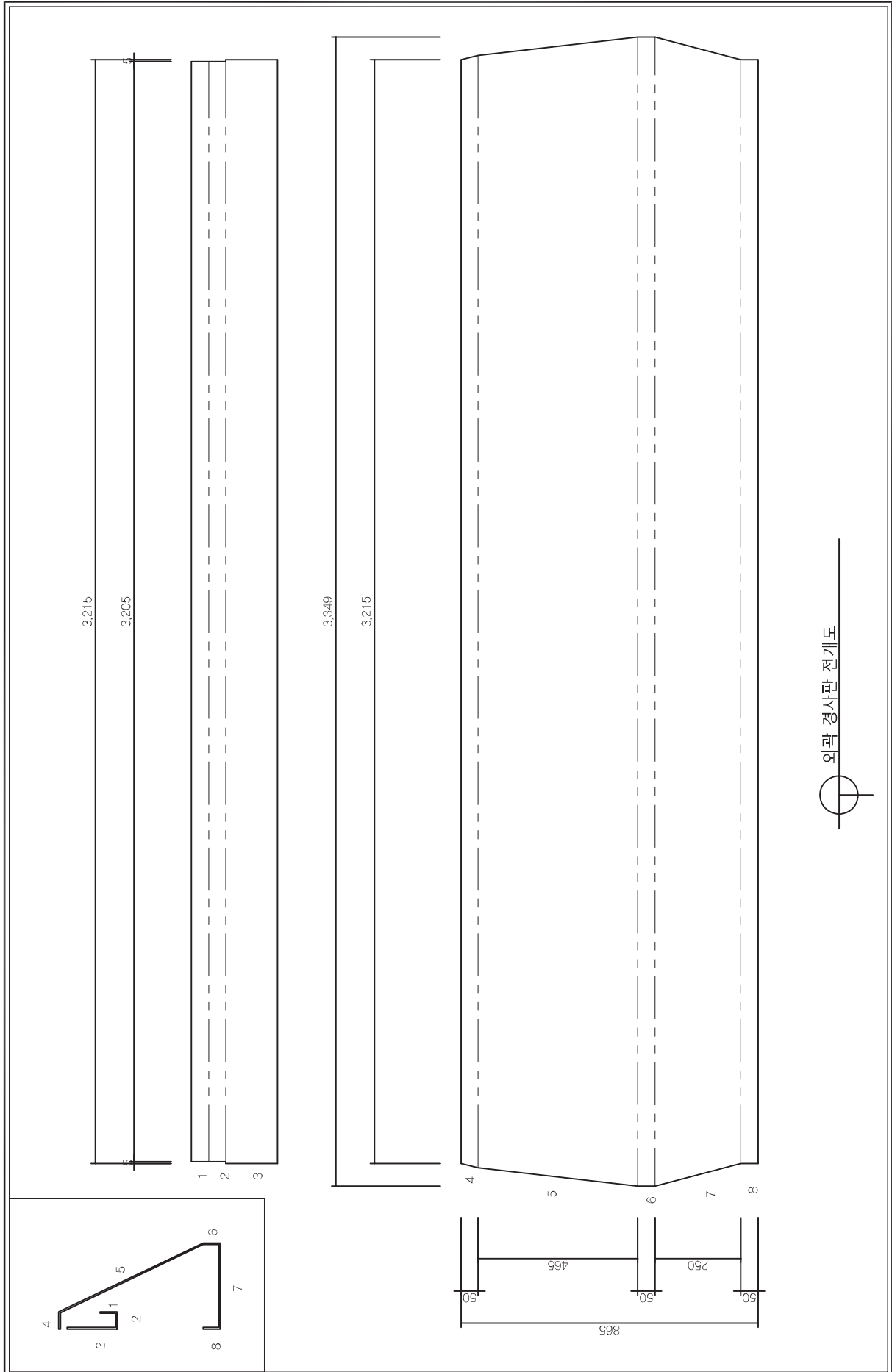

외관 경사판 전개도

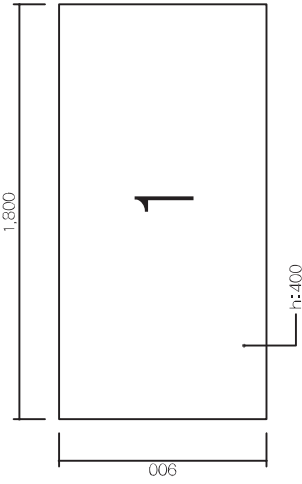
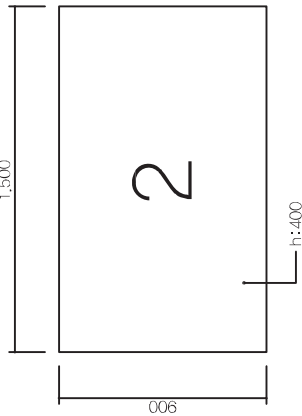
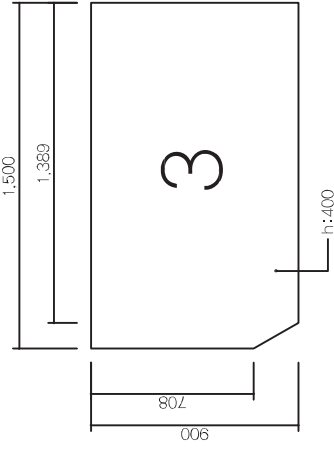
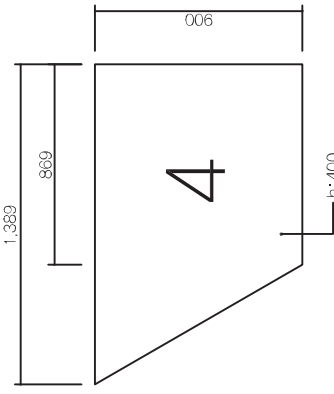
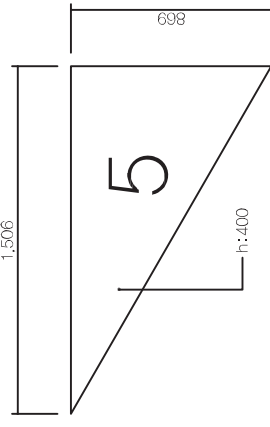
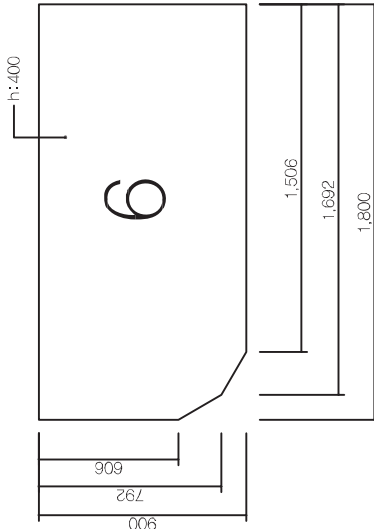

<p>Quantity : 46ea</p>  <p>스티로폼 1번</p>	<p>Quantity : 8ea</p>  <p>스티로폼 5번</p>	<p>Quantity : 8ea</p>  <p>스티로폼 3번</p>
<p>Quantity : 8ea</p>  <p>스티로폼 4번</p>	<p>Quantity : 8ea</p>  <p>스티로폼 5번</p>	<p>Quantity : 4ea</p>  <p>스티로폼 6번</p>

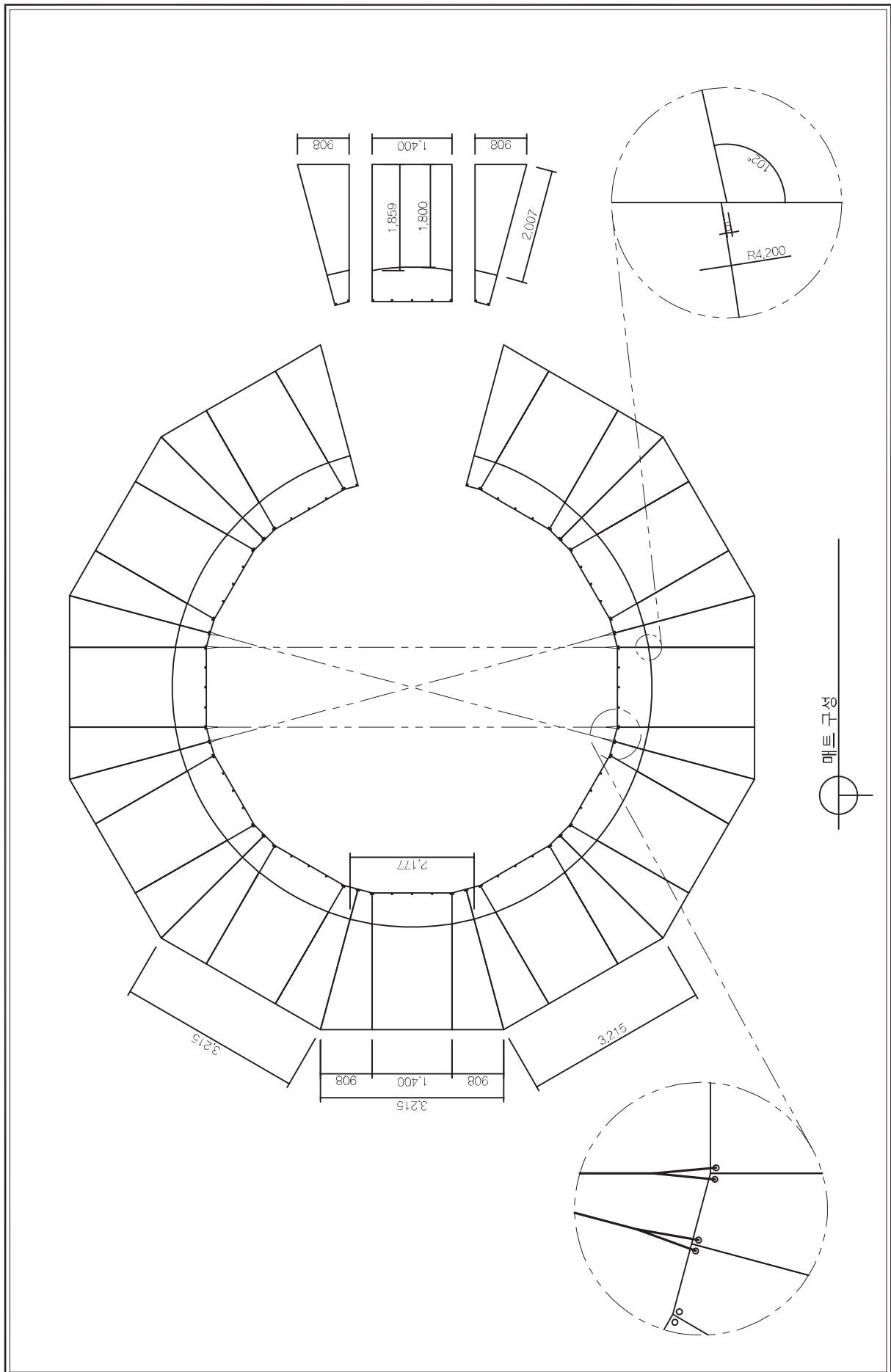

Quantity : 12set

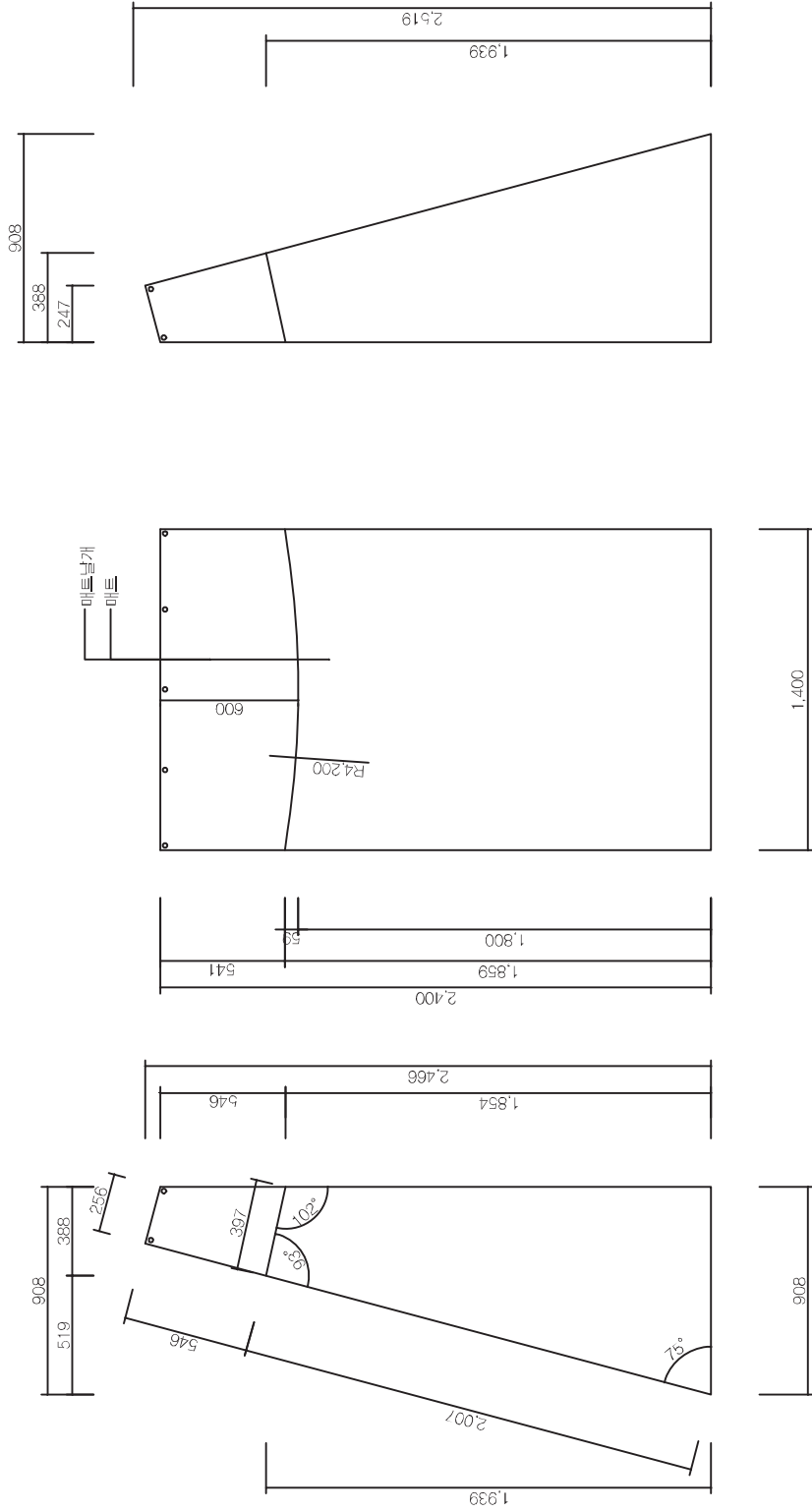

매트

Quantity : 2ea

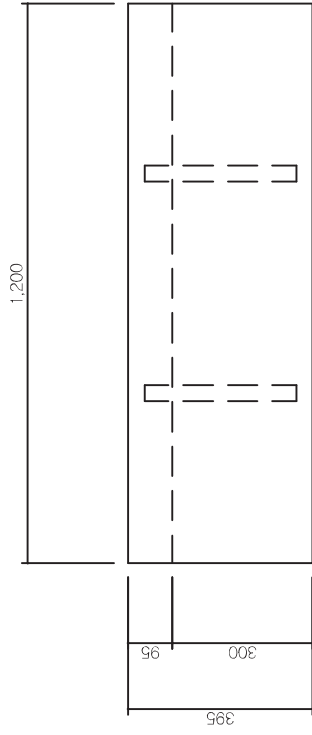

평면

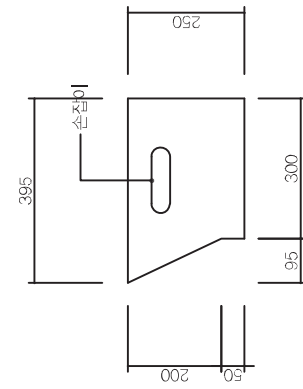

좌측면

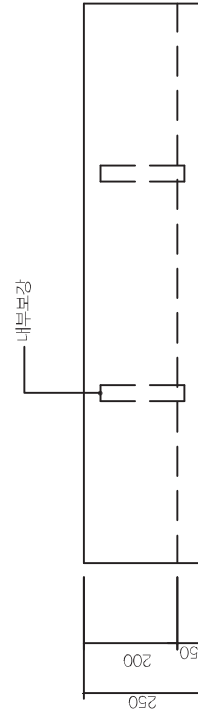

평면



이동식 계단



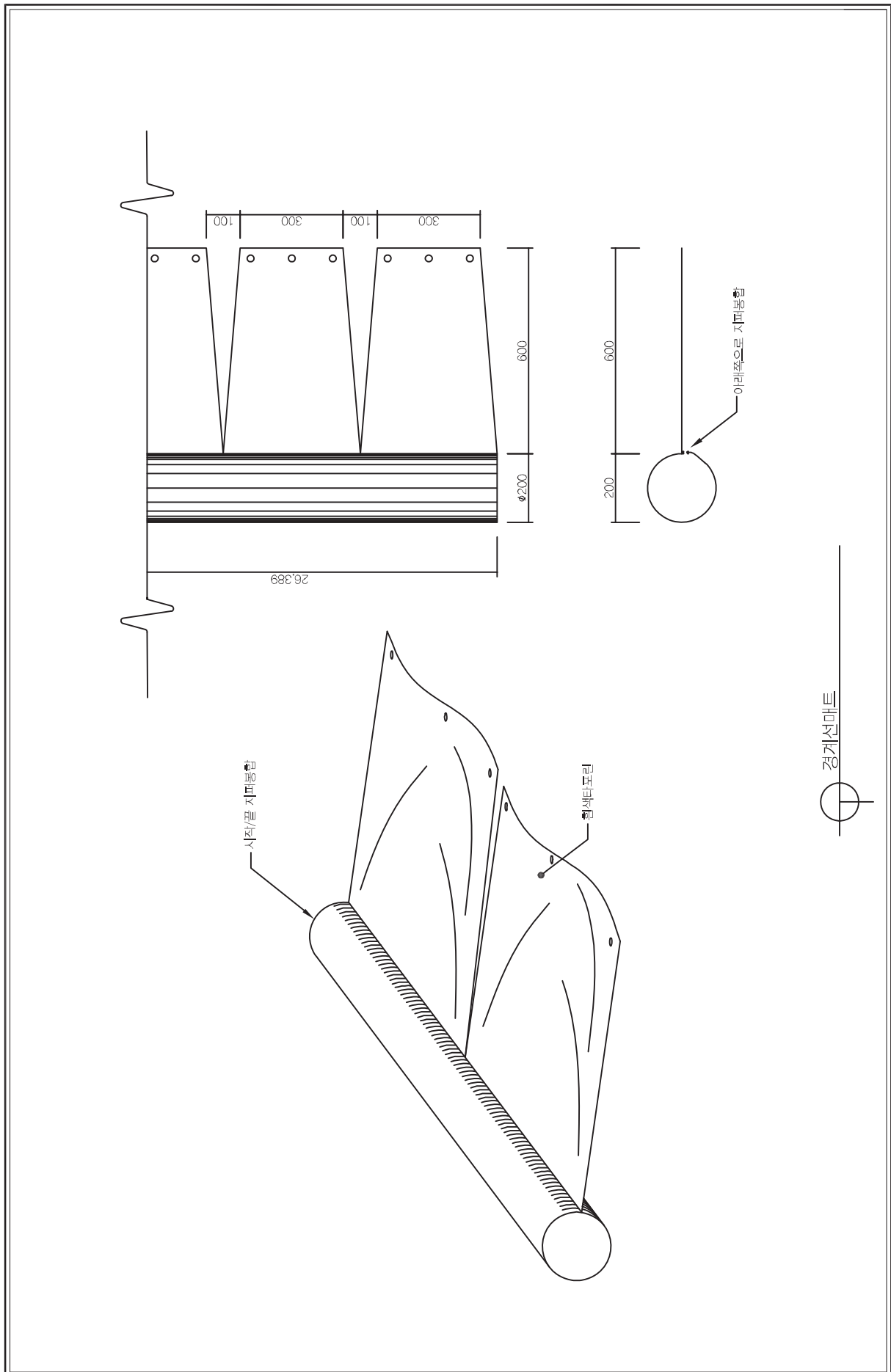

경계선매트

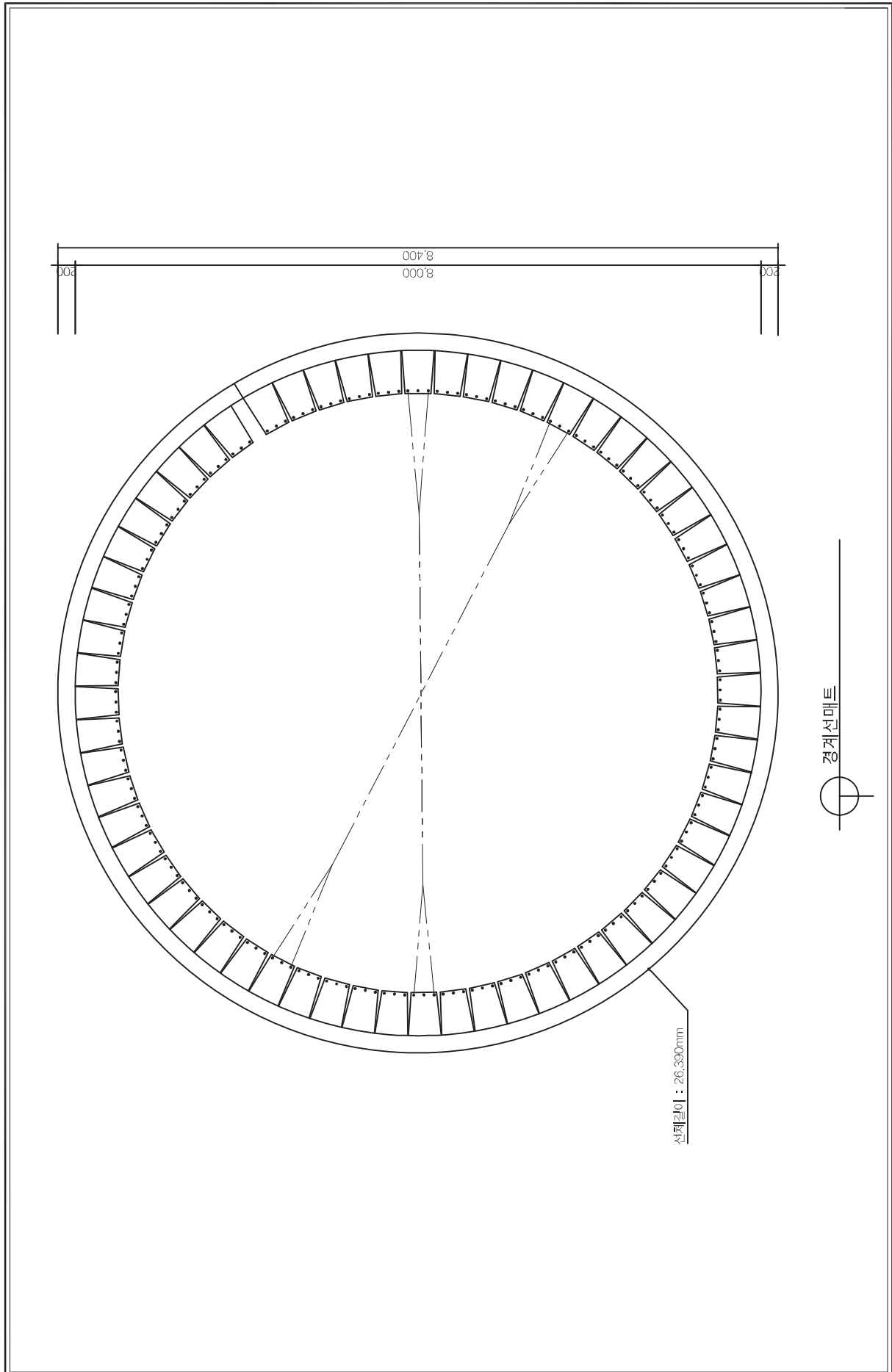

Quantity : 12set

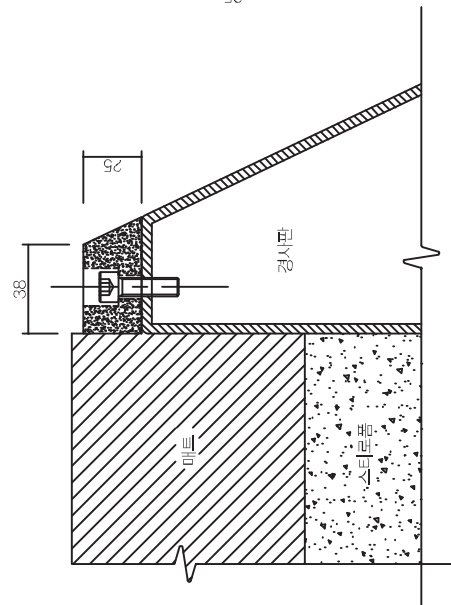
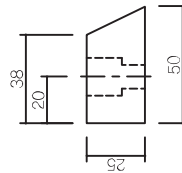
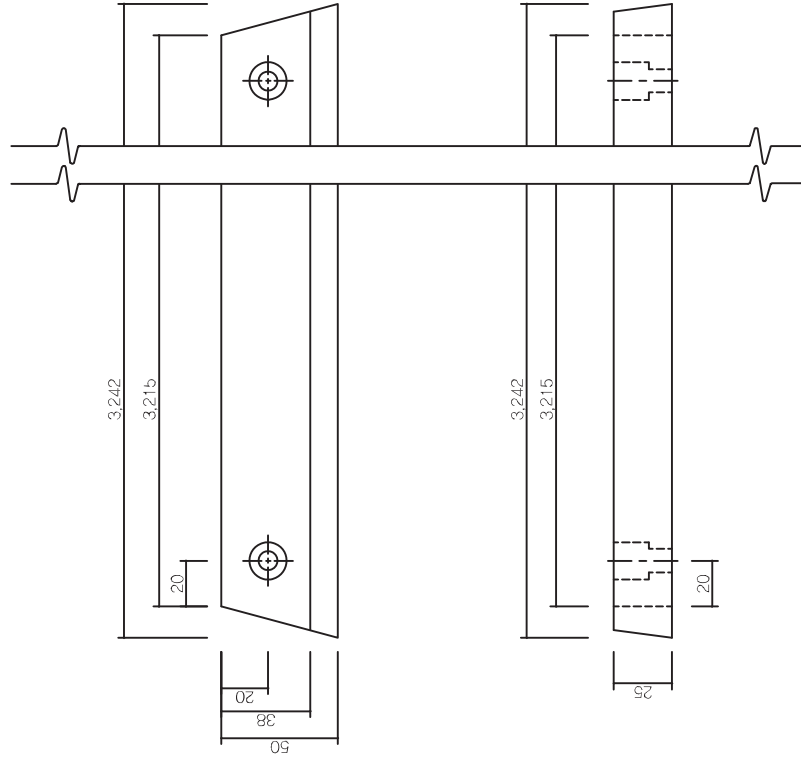

모서리 곡선



Quantity : 12ea

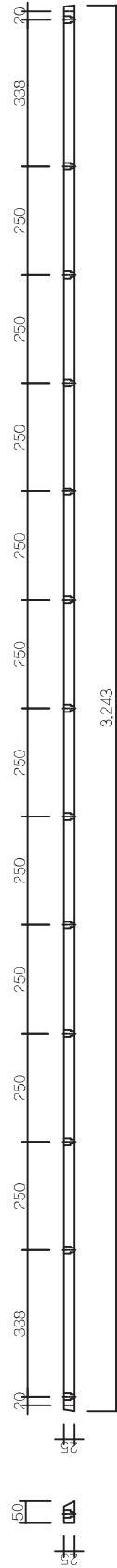
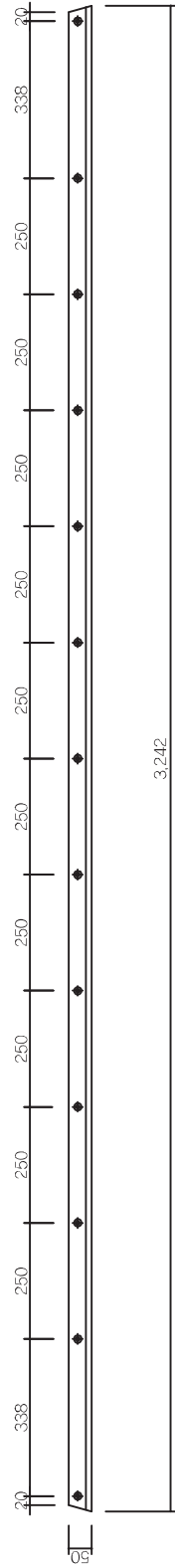

모서리 곡선

Quantity : 10ea

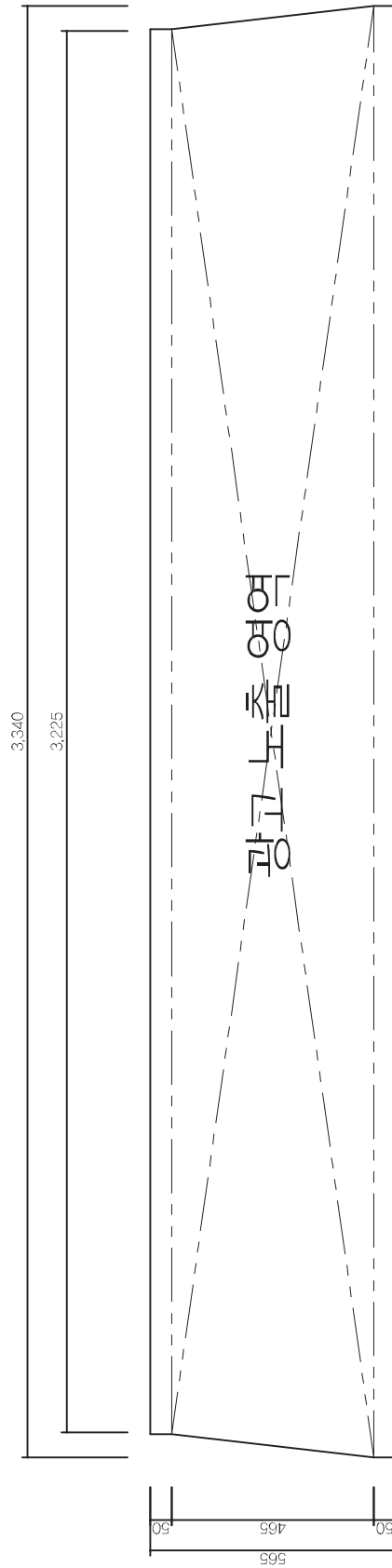
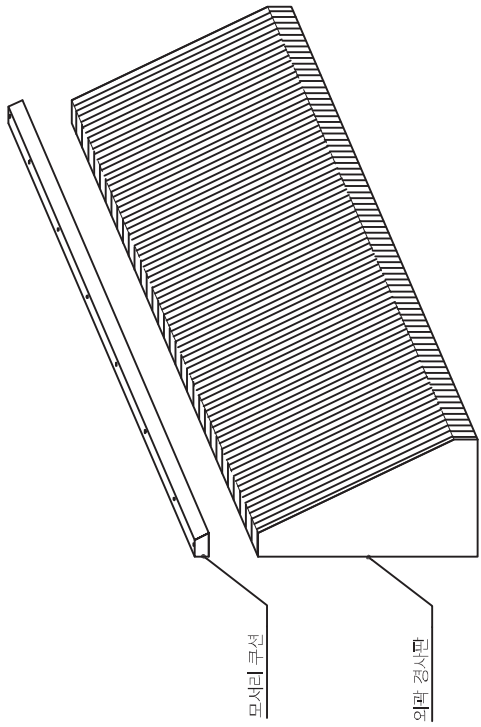
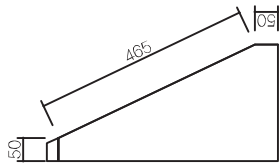

광고판 부착물

Quantity : 2ea

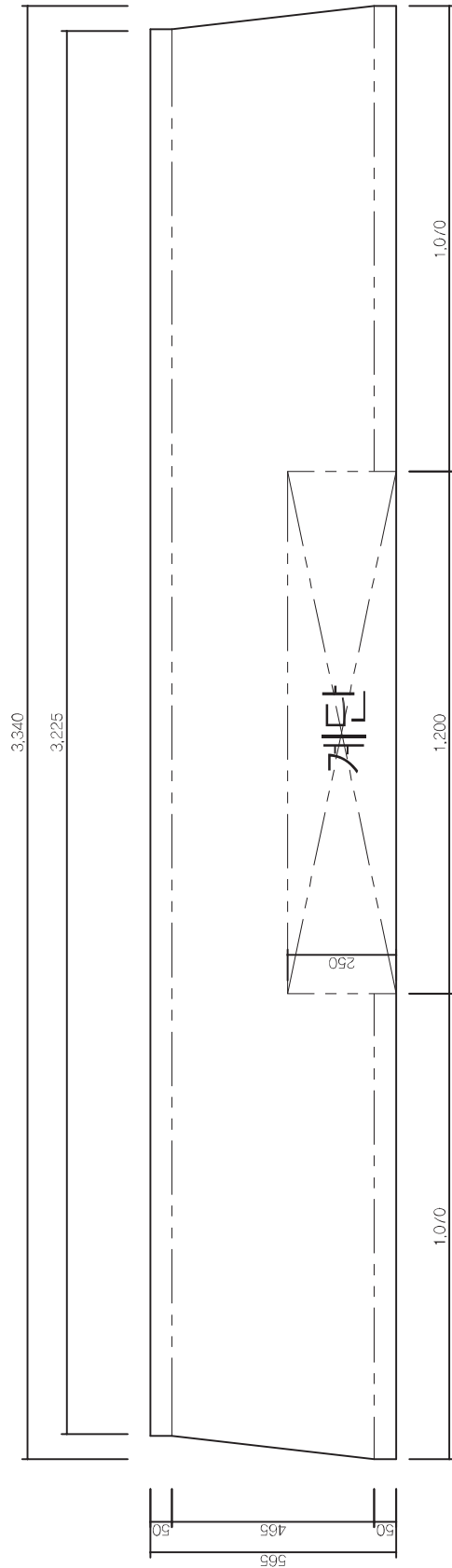
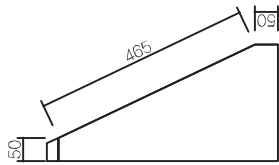
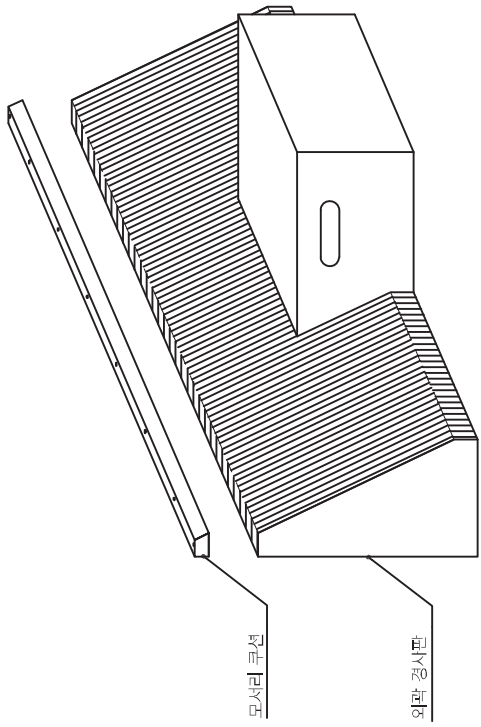

광고판 부착물

